

# Check Valves

## CO Series



Check Valves  
Relief Valves

# Check Valves

## CO Series



### Features

#### CV Series

- ⦿ Resilient O-ring seat design for leak free sealing
- ⦿ Working pressure up to: 3000 psig (207 bar)
- ⦿ Working temperature: -10°F to 375°F (-23°C to 190°C)
- ⦿ Cracking pressure: 1/3 to 25 psig (0.02 to 1.7 bar)
- ⦿ Variety of end connections and materials available
- ⦿ Fixed cracking pressure, mountable in any directions

#### CH Series

- ⦿ Seat ring continuously cleaned by media, avoiding secondary pollution
- ⦿ Working pressure up to: 6000 psig (414 bar)
- ⦿ Working temperature: -10°F to 400°F (-23°C to 204°C)
- ⦿ Cracking pressure: 1/3 to 25 psig (0.02 to 1.7 bar)
- ⦿ Variety of end connections and materials available
- ⦿ Fixed cracking pressure, mountable in any directions
- ⦿ ECE R110 type approved valves for use in CNG/NGV application are available

#### CO Series

- ⦿ Compact design, one piece body
- ⦿ Working pressure up to: 3000 psig (207 bar)
- ⦿ Working temperature: -10°F to 375°F (-23°C to 190°C)
- ⦿ Cracking pressure: 1/3 to 25 psig (0.02 to 1.7 bar)
- ⦿ Variety of end connections and materials available
- ⦿ Fixed cracking pressure, mountable in any directions

#### CA Series

- ⦿ Working pressure up to: 3000 psig (207 bar)
- ⦿ Working temperature: -10°F to 375°F (-23°C to 190°C)
- ⦿ Cracking pressure: 3 to 600 psig (0.2 to 41.4 bar)
- ⦿ Variety of end connections and materials available
- ⦿ Various springs available
- ⦿ Adjustable cracking pressure, mountable in any directions

#### COA Series

- ⦿ Compact design, one-piece body
- ⦿ Working pressure up to: 3000 psig (207 bar)
- ⦿ Working temperature: -10°F to 375°F (-23°C to 190°C)
- ⦿ Cracking pressure: 3 to 600 psig (0.2 to 41.4 bar)
- ⦿ Variety of end connections and materials available
- ⦿ Various springs available
- ⦿ Adjustable cracking pressure, mountable in any directions

#### CL Series

- ⦿ Working pressure up to: 6000 psig (414 bar)
- ⦿ Working temperature: -65°F to 900°F (-53°C to 482°C)
- ⦿ Rugged, all-stainless steel construction
- ⦿ Union bonnet design, all-stainless steel structure, horizontal installation with bonnet nut on top
- ⦿ Reverse flow coefficient less than 0.1% of forward flow coefficient

#### CW Series

- ⦿ Working pressure up to: 3000 psig (207 bar)
- ⦿ Working temperature: -10°F to 400°F (-23°C to 204°C)
- ⦿ Cracking pressure: less than 2 psig (0.14 bar)
- ⦿ Variety of end connections and materials available
- ⦿ All-welded design for safety
- ⦿ Standard or fine polished wetted surfaces optional

1. Besides CL series, other check valves are all coated with lubricants like silicone base and molybdenum disulfide base.
2. Please contact FITOK Group or our authorized distributors for other materials.
3. PTFE-coated spring is an option for CV, CO, CA, and COA series check valves. For more details, please contact FITOK Group or our authorized distributors.
4. Every valve is tested with nitrogen for leak-tight performance at its maximum working pressure.

## Cracking Pressure and Reseal Pressure

**Cracking pressure** - the upstream pressure at which the first indication of flow occurs.

**Reseal pressure** - the pressure at which there is no indication of flow.

Series	Nominal Cracking Pressure psig (bar)	Cracking Pressure Range psig (bar)	Reseal Pressure Range psig (bar)
CV	1/3 (0.02) 1 (0.06) 3 (0.21) 10 (0.68) 25 (1.7)	0 to 3 (0 to 0.21) 0 to 4 (0 to 0.28) 1 to 5 (0.06 to 0.34) 7 to 15 (0.49 to 1.1) 20 to 30 (1.4 to 2.1)	Up to 6 (0.42) downstream pressure Up to 6 (0.42) downstream pressure Up to 6 (0.42) downstream pressure 3 (0.21) or higher upstream pressure 17 (1.2) or higher upstream pressure
CH	1/3 (0.02) 1 (0.06) 3 (0.21) 10 (0.68) 25 (1.7)	0 to 3 (0 to 0.21) 0 to 4 (0 to 0.28) 1 to 5 (0.06 to 0.34) 7 to 15 (0.49 to 1.1) 20 to 30 (1.4 to 2.1)	Up to 6 (0.42) downstream pressure Up to 5 (0.35) downstream pressure Up to 2 (0.14) downstream pressure 3 (0.21) or higher upstream pressure 17 (1.2) or higher upstream pressure
CO	1/3 (0.02) 1 (0.06) 3 (0.21) 10 (0.68) 25 (1.7)	0 to 3 (0 to 0.21) 0 to 4 (0 to 0.28) 1 to 5 (0.06 to 0.34) 7 to 15 (0.49 to 1.1) 20 to 30 (1.4 to 2.1)	6 to 20 (0.42 to 1.4) downstream pressure 5 to 20 (0.35 to 1.4) downstream pressure 3 to 20 (0.21 to 1.4) downstream pressure 3 to 10 (0.21 to 0.68) downstream pressure 5 (0.35) or higher upstream pressure
CA	3 to 50 (0.21 to 3.4) 50 to 150 (3.4 to 10.3)	—————	Refer to the chart below
COA	150 to 350 (10.3 to 24.1) 350 to 600 (24.1 to 41.3)		
CW	1/3 (0.02)	0 to 2 (0 to 0.14)	Up to 2 (0.14) downstream pressure

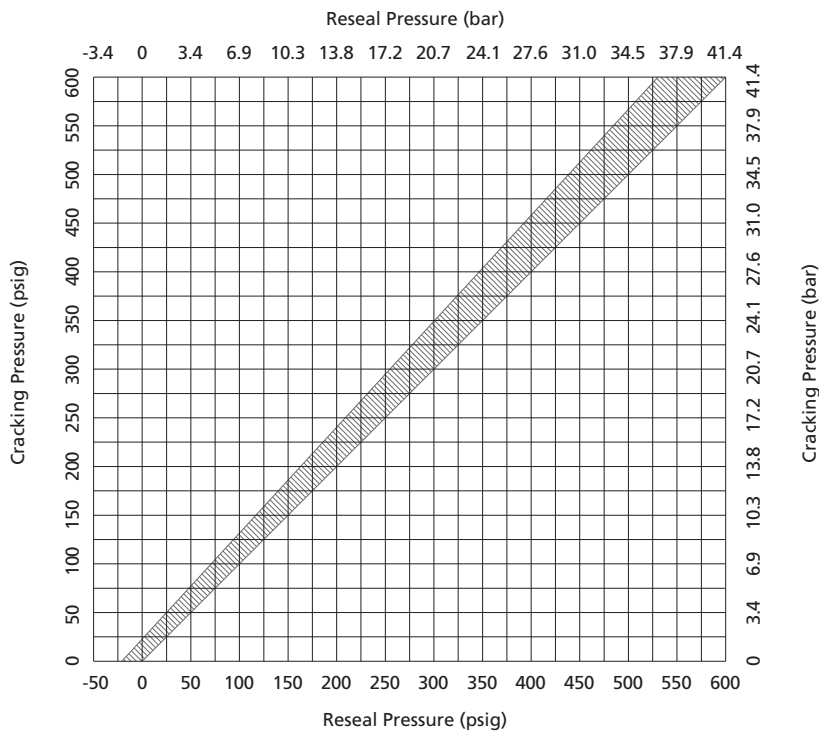

## Pressure vs. Temperature

### CV Series

FKM O-ring in 316 SS Body and Buna N in Brass Body

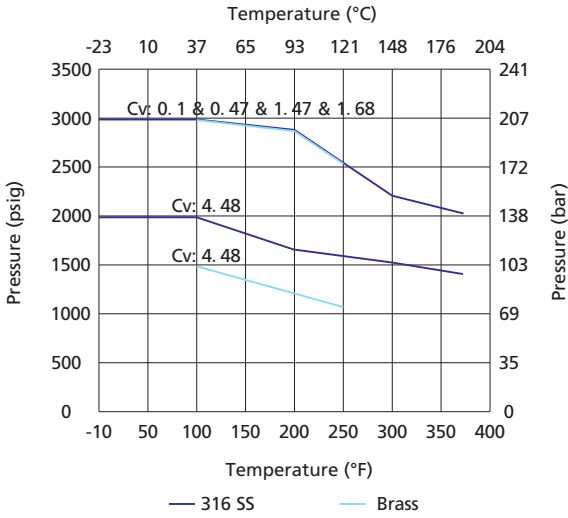

### CO, CA and COA Series

FKM O-ring in 316 SS Body and Buna N in Brass Body

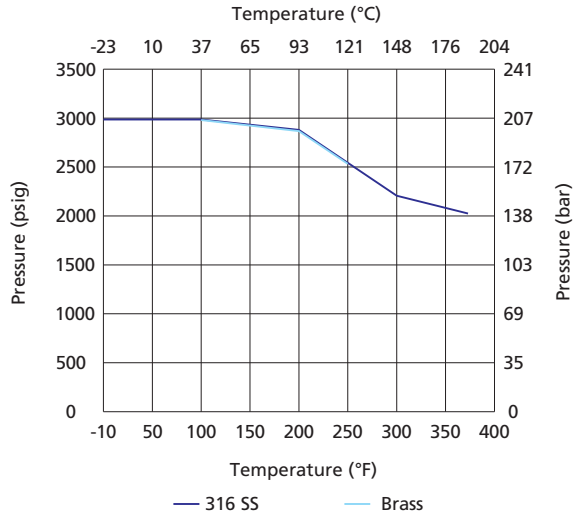

### CL Series

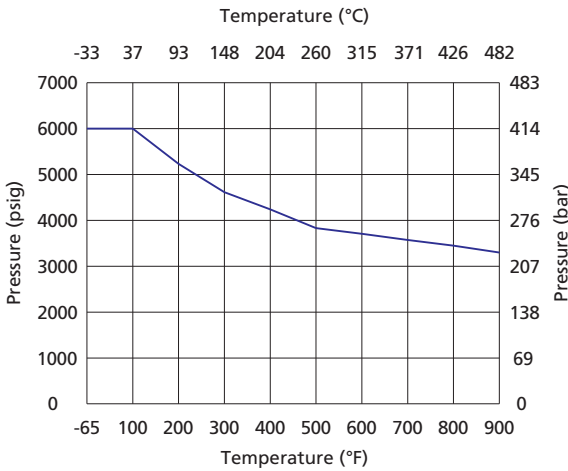

### CH Series

FKM O-ring in 316 SS Body

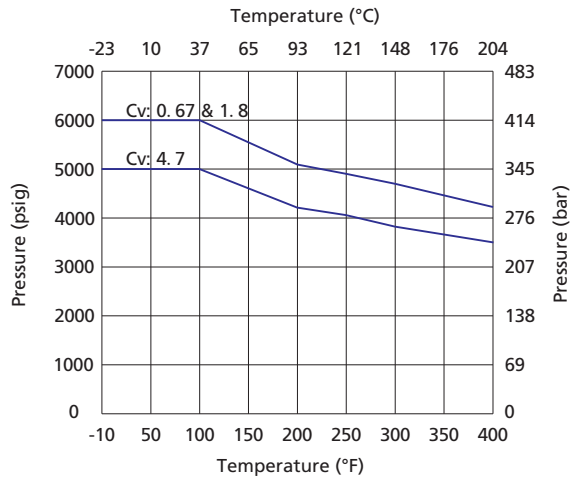

### CW Series

FKM O-ring in 316 SS Body

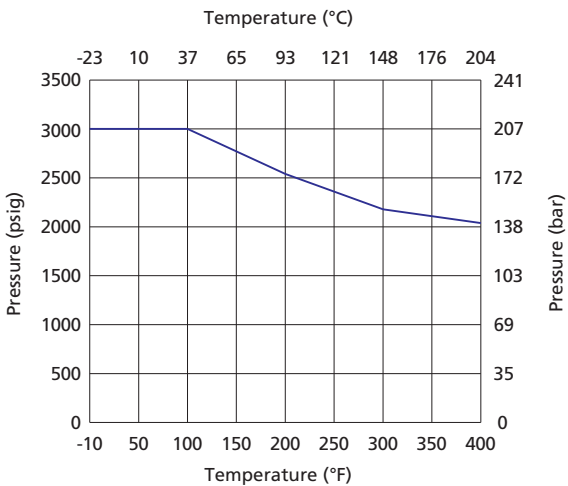

The temperature rating of CH Series check valve is restricted by the connection types. For details please refer to B-134.

## Standard Materials of Construction

### CV Series

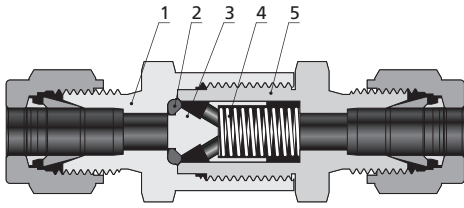

Component	Material Grade/ASTM Specification	
	316 SS	Brass
1 Inlet Body	316 SS/A479	Brass C36000/B16
2 O-ring	Fluorocarbon FKM	Buna N
3 Poppet	316 SS/A479	Brass C36000/B16
4 Spring	302 SS/A313	302 SS/A313
5 Outlet Body	316 SS/A479	Brass C36000/B16

### CH Series

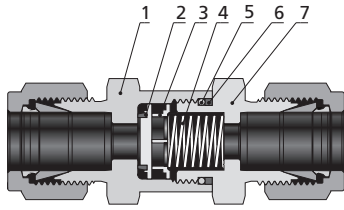

Component	Material Grade/ASTM Specification
1 Inlet Body	316 SS/A479
2 Poppet	Fluorocarbon-FKM-bonded 316 SS/A479
3 Poppet Stop	316 SS/A240
4 Spring	302 SS/A313
5 O-ring	Fluorocarbon FKM
6 Backup Ring	PTFE/D1710
7 Outlet Body	316 SS/A479

### CO Series

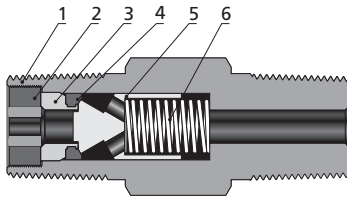

Component	Material Grade/ASTM Specification	
	316 SS	Brass
1 Body	316 SS/A479	Brass C36000/B16
2 Insert Locking Screw	316 SS/A276 or A479	Brass C36000/B16
3 Insert	316 SS/A479	Brass C36000/B16
4 O-ring	Fluorocarbon FKM	Buna N
5 Poppet	316 SS/A479	Brass C36000/B16
6 Spring	302 SS/A313	302 SS/A313

### CA Series

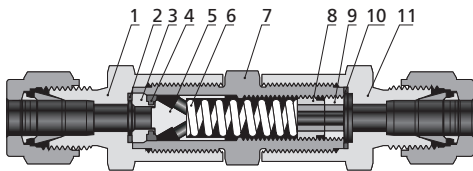

Component	Material Grade/ASTM Specification	
	316 SS	Brass
1 Inlet Body	316 SS/A479	Brass C36000/B16
2 Inlet Gasket	PTFE-coated 316 SS/A240	PTFE-coated 316 SS/A240
3 Insert	316 SS/A479	Brass C36000/B16
4 O-ring	Fluorocarbon FKM	Buna N
5 Poppet	316 SS/A479	Brass C36000/B16
6 Spring	302 SS/A313	302 SS/A313
7 Center Body	316 SS/A479	Brass C36000/B16
8 Adjusting Screw	316 SS/A276	316 SS/A276
9 Locking Screw	316 SS/A276	316 SS/A276
10 Outlet Gasket	PTFE-coated 316 SS/A276	PTFE-coated 316 SS/A276
11 Outlet Body	316 SS/A479	Brass C36000/B16

CO Series

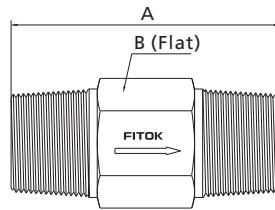

Basic Ordering Number	Connection Type and Size		Cv	Dimensions, in. (mm)	
	Inlet	Outlet		A	B
CO□□-FNS4-	1/4 Female NPT	1/4 Female NPT	0.35	2.41 (61.2)	3/4 (19.1)
CO□□-FNS8-	1/2 Female NPT	1/2 Female NPT	1.20	3.71 (94.2)	1 1/16 (27.0)
CO□□-NS4-	1/4 Male NPT	1/4 Male NPT	0.35	1.62 (41.1)	9/16 (14.3)
CO□□-NS8-	1/2 Male NPT	1/2 Male NPT	1.20	2.28 (57.9)	7/8 (22.2)
CO□□-FRT4-	1/4 Female BSPT	1/4 Female BSPT	0.35	2.54 (64.5)	3/4 (19.1)
CO□□-RT4-	1/4 Male BSPT	1/4 Male BSPT		1.62 (41.1)	9/16 (14.3)

Ordering Number Description

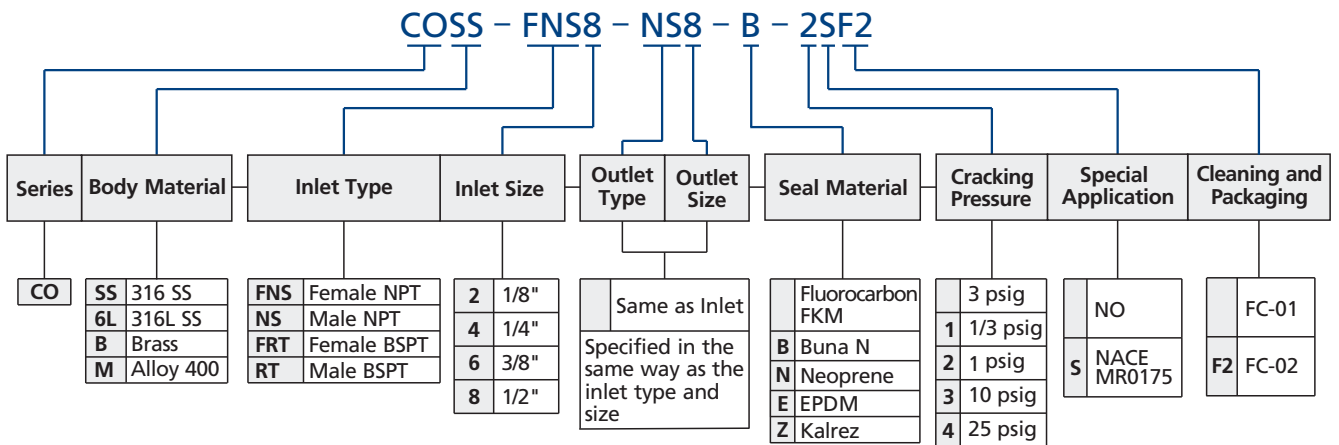

1. For oxygen-enriched environment or hazardous media service, please contact FITOK Group or our authorized distributors.
2. Cleaning and Packaging:  
 FC-01: Standard cleaning and packaging for general industrial procedures.  
 FC-02: Special cleaning and packaging for wetted system components to ensure compliance with product cleanliness requirement of ASTM G93 Level C.
3. The materials, connection types and sizes listed in the "Ordering Number Description" are standard. For other materials and end connections, please contact FITOK Group or our authorized distributors.
4. Check valve is designed with unidirectional flow path, it can't be used as safety relief valve.
5. If the check valve is not opened for a period of time, its initial cracking pressure may be higher than set cracking pressure.



正規販売代理店  
株式会社ナイフェスト

TEL : 050-5213-1839  
watabe@nafest.co.jp  
<https://www.nafest.co.jp>